

Sistem EW-FU

OPIS

Klasik kod sanacija: Jednostijeni dimovodni sistem od nehrđajućeg čelika za modernizaciju i smanjenje poprečnog presjeka postojećih kućnih dimnjaka, priključnih dimovoda te za ventilacijski sistem

MATERIJAL

1.4404(316L) / 1.4571 (316Ti) / 1.4828 dostupan uz nadoplatu, ostali dostupni na upit

POVRŠINA

Matirana

DEBLJINA STIJENKE

0,6 mm/1,0 mm / ostali dostupni na upit

UNUTARNJI PROMJER

80 - 600 mm, ostali dostupni na upit do 1200 mm

IZOLACIJA

Alternativno moguće sa izolacijskom oblogom

SPOJ

Utični spoj spojnica/žlijeb

SVOJSTVA SISTEMA

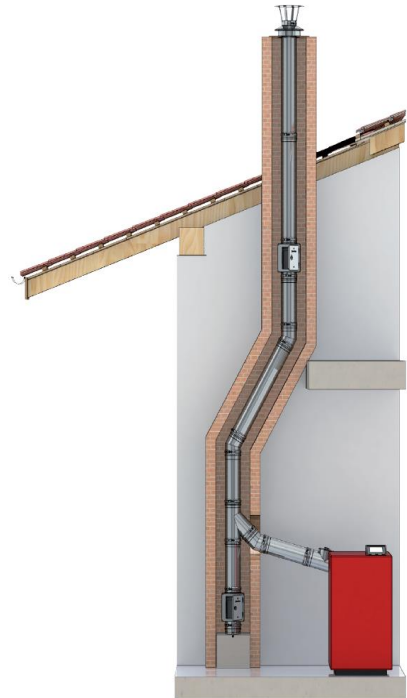

SVOJSTVA

- ✓ Otporan na čađu i vatru ili neosjetljiv na vlagu
- ✓ Brza montaža i jednostavni obilazni vod zahvaljujući laganom materijalu
- ✓ Alternativno je moguće učvršćivanje pomoću obujmica
- ✓ Alternativno je moguća isporuka kao ovalna cijev idealno za uske i višeslojne sisteme
- ✓ Velika raznovrsnost sistema i bogata ponuda pribora

PODRUČJA PRIMJENE

- ✓ Standardna ložišta za ulje, plin, kruta goriva (prirodno čisto drvo, koks, treset, ugljen)

EW - FU

BROJ CE-CERTIFIKATA

0036 CPR 9174 006

CE-KLASIFIKACIJE SUKLADNO NORMI DIN EN 1856 - 1

T400 - N1 - D - V2 - L50060 - Gxx

T400 - N1 - W - V2 - L50060 - Oxx

T600 - N1 - D - V2 - L50060 - Gxx

T600 - N1 - W - V2 - L50060 - Oxx

T600 - N1 - D - V3 - L50060 - Gxx¹

¹ uz izolaciju od 25 mm

xx = Razmak od zapaljivih materijala ovisi o Ø, pogledajte Izjavu o sukladnosti proizvođača

EW - FU SPOJNI PRIKLJUČAK DIMOVODA

BROJ CE-CERTIFIKATA

0036 CPD 9174 026

CE-KLASIFIKACIJE SUKLADNO NORMI DIN EN 1856 - 2

T400 - N1 - D - V2 - L50060 - G400M

T400 - N1 - W - V2 - L50060 - O400M

bez zaštite od zračenja

T400 - N1 - D - V2 - L50060 - G300¹

T400 - N1 - W - V2 - L50060 - O300¹

¹ uz zaštitu od zračenja

Sistem EW-FU 0,6 mm



POČETAK DIMNJAKA	ELEMENT S REVIZIJSKIM OTVOROM			VRATAŠKA		
posuda za kondenzat s odvodnom cijevi 250 mm	element s reviz. otvorom s poklopcem 210 x 140 mm	element s reviz. otvorom s kutijom 210 x 140 mm	element s reviz. otv. s kutijom i poklopcem 210 x 140 mm	inox vrataška 210 x 140 mm, s pomičnim nastavkom 60 mm	inox vrataška 300 x 150 mm, s pomičnim nastavkom 60 mm	inox vrataška 210 x 140 mm
						
FU01	FU0607	EW0607	FU0607K	FU0960	FU1060	FU13

UZIDNICA		T-PRIKLJUČAK			
uzidnica inox, duplostijena	uzidnica inox, duplostijena za Ferro	T-priključni komad 87° s okapnicom za ispušt, 108 mm	T-priključni komad 45° s okapnicom	T-Klix 87° s okapnicom, 150 mm	"T-Klix 90° s kukastim zaporima za bočno zakretanje"
					
FU42	FU42F	FU0615	FU0616	FU0649	FU061326





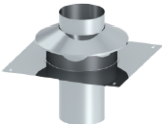

VERTIKALA DIMOVODA						
odstojnik	dimovodna cijev 1000 mm	dimovodna cijev 500 mm	dimovodna cijev 250 mm	dimovodna cijev 1000 mm s ušicama za upuštanje	dimovodna cijev 1000 mm s duplom spojnicom	dimovodna cijev 1000 mm sa odstojnikom
						
FU40	FU0602	FU0603	FU0604	FU0605	FU0606	FU0670







Sistem EW-FU 0,6 mm

IZOLACIJA		KOLJENA		
izolacijska obloga 20 mm	izolacijska obloga 25 mm	koljeno 15° fiksno	koljeno 30° fiksno	koljeno 45° fiksno
				
FU39-20	FU39-25	FU0617	FU0618	FU0619



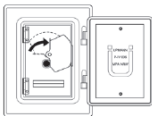



ZAVRŠNA KAPA			
pokrov otvora s obručem protiv padalina	univerzalna kapa sa prstenastom ventilacijom i obr. protiv padalina	protukišna kapa	protukišna kapa inox s umetkom, 4 učvrsnice
			
FU0625	FU06130	FU28	FU1265

Sistem EW-FU 0,6 mm dodatni dijelovi

POČETAK DIMNJAKA				ELEMENT S REVIZIJSKIM OTVOROM		
posuda za kondenzat s 1/2" spojnicom i zatvaračem	posuda za kondenzat sa 1/2" spojnicom	posuda za kondenzat sa ispustom prema dolje	posuda za kondenzat bez ispusta	element s revizijskim otvorom s poklopcem 300x150 mm	element s revizijskim otvorom s kutijom i poklopcem 300x150 mm	element s revizijskim otvorom, okrugli do 600°C
						
FU01A	FU01B	FU94B	FU95B	FU0608	FU0608K	FU0607R

ELEM.S REV. OTV.	VRATAŠKA				T-PRIKLJUČAK	
element s revizijskim otvorom 500 mm	inox vratašca 300x200 mm, s pomičnim nastavkom 50 mm	inox vratašca 300x150 mm	inox vratašca 210x140 mm, sa integriranom zaštitom od čađe	klizni nastavak 150/500/1000 mm za produženje FU13, 150 mm	klizni nastavak 150/500/1000 mm za produženje FU14, 500 mm	T-priključni komad 60° sa okapnicom
						
FU06113	FU116050	FU14	FU55	FU11	FU12	FU0631







SPOJNI PRIKLJUČAK DIMOVODA						
dimovodna cijev 250 mm sa ispust. kond.za okom.& horiz. ugradnju	dimovodna cijev 250 mm s ispustom kondenzata za horiz.ugradnju	klizni element 320-480 mm	mjerni element 200 mm (do 200°C)	obruč protiv padalina/zidna rozeta	obujmica	zidni držač razmaka, fiksni, 50 mm
						
FU06110	FU06111	FU06114	FU06112	FU72	FU45	VL09

SPOJNI PRIKLJUČAK DIMOVODA				KOLJENA		
zidni držač podesivi, 50-360 mm	potpora 800-1200 mm	stropni ovsje za perforiranu traku s uloškom za priguš. buke	stropni ovsje za navojnu šipku M8 s umetkom za prigušivanje buke	koljeno 87° fiksno	koljeno 90° fiksno	element s revizijskim otvorom 87°, fiksni
						
VL293	VL11	VL12	VL16	FU0622	FU0629	FU0623

Sistem EW-FU 0,6 mm dodatni dijelovi





KOLJENA				PRIBOR		
koljeno 90° s revizijskim otvorom, fiksno (do 600°C)	koljeno okretno 0-90°	koljeno s revizijskim otvorom, okretno 0-90°	koljeno, okretno 0-45°	1/2" spojnica sa zapornim vijkom	univerzalni priključak utični, konusni	priključak kotla/ utični spoj
						
FU0624	FU06101	FU06102	FU0621	FU125	FU06120	FU0632



PRIBOR						
nadoplata za 1/2" spojnicu	montažna spojnica 1/2" s graničnikom	priključak kotla/ utični spoj, konusno	međupotporanj sa kompenzatorom rastezanja	univerzalni brtveni set za priključak kotla	regulator uzgona/ inox 210x140 mm	priključak za regulator uzgona okrugli, izlaz Ø 150 mm
						
FU126	FITT27018	FU06123	FU0633	AL45V	FU35	FU0636

PRIBOR						
regulator uzgona/inox Ø 150 mm za montažu FU36	regulator uzgona/inox Ø154 mm sa štucnom i zateznom trakom	rešetka za ventilaciju Ø 130 mm, okrugla	međudržač	navojna šipka M8	produljenje cijevi za odvod kondenzata Ø 20x1,5 mm	nadoplata za 1/2" niplu
						
FU38	VL08E	FU85	FU312	VL314	FU48	FU128

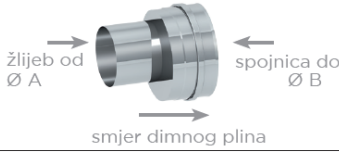
PRIBOR						
sifon lijevo / desno / ravno	slavina za odvod kondenzata sa 1/2" vanjskim navojem	poklopac bez zatezne brtve, matiran	poklopac za uzidnicu	poklopac nastavni sa ručkom i obujmicom	obujmica za priključak na kotao	mineralna vuna, vreća 6 kg
						
FU46	FU47	FU50	FU43	FU44	FU1518	MINERAL-6

Sistem EW-FU 0,6 mm dodatni dijelovi

PRIBOR		PRIJELAZ	
prsten za učvršćivanje 2-dijelni za navojnu šipku M10	navojna šipka M10	ekscentrično proširenje	proširenje
			
ZUWA1379	VL316	EWE-EX	EWE

PRIJELAZ	
redukcija	priključni nastavak s integriranom uzidnicom
	
EWR	ZUWA757

Sistem EW-FU 1,0 mm

POČETAK DIMNJAKA	ELEMENT S REVIZIJSKIM OTVOROM			VRATAŠČA		
posuda za kondenzat s odv. cijevi 250 mm, Ø 17 x 1.5 mm	element s revizijskim otvorom s poklopcem 210 x 140 mm	element s revizijskim otvorom s kutijom 210 x 140 mm	element s revizijskim otvorom s kutijom i poklopcem 210 x 140 mm	inox vratašča 210 x 140 mm, s pomičnim nastavkom 60 mm	inox vratašča 300 x 150 mm, s pomičnim nastavkom 60 mm	inox vratašča 210 x 140 mm
						
FU01	FU1007	EW1007	FU1007K	FU0960	FU1060	FU13





UZIDNICA	T-PRIKLJUČAK			VERTIKALA DIMOVODA		
uzidnica inox, duplostijena	uzidnica inox, duplostijena, prikladna za dimnjaču od 2 mm	T-priključni komad 87° sa okapnicom za ispušt, 108 mm	T-priključni komad 45° sa okapnicom	T-Klix 87° sa okapnicom za ispušt, 150 mm	odstojnik	dimovodna cijev 1000 mm
						
FU42	FU42F	FU1015	FU1016	FU1049	FU40	FU1002

VERTIKALA DIMOVODA					IZOLACIJA	
dimovodna cijev 500 mm	dimovodna cijev 250 mm	dimovodna cijev 1000 mm s ušicama za upuštanje	dimovodna cijev 1000 mm s duplom spojnicom	dimovodna cijev 1000 mm sa odstojnikom	izolacijska obloga 20 mm	izolacijska obloga 25 mm
						
FU1003	FU1004	FU1005	FU1006	FU1070	FU39-20	FU39-25

KOLJENA			ZAVRŠNA KAPA			
koljeno 15° fiksno	koljeno 30° fiksno	koljeno 45° fiksno	pokrov otvora sa obručem protiv padalina	univerzalna kapa sa prstenastom ventilacijom i obruč. protiv padalina	protukišna kapa	protukišna kapa inox s umetkom, 4 učvršnice
						
FU1017	FU1018	FU1019	FU1025	FU10130	FU28	FU1265

Sistem EW-FU 1,0 mm dodatni dijelovi

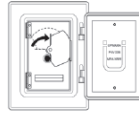





POČETAK DIMNJAKA				ELEMENT S REVIZIJSKIM OTVOROM		
posuda za kondenzat s 1/2" spojnicom i zatvaračem	posuda za kondenzat sa 1/2" spojnicom	posuda za kondenzat sa ispuštom prema dolje	posuda za kondenzat bez ispusta	element s reviz. otvorom s poklopcem 300 x 150 mm	element s reviz. otvorom s kutijom i poklopcem 300 x 150 mm	element s reviz. otvorom, okrugli
						
FU01A	FU01B	FU94B	FU95B	FU1008	FU1008K	FU1007R

ELEM.S REV. OTV.	VRATAŠKA				T-PRIKLJUČAK
element s reviz. otvorom 500 mm	inox vrataška 300x200 mm, s pomičnim nastavkom 50 mm	inox vrataška 300x150 mm	inox vrataška 210x140 mm, sa integriranom zaštitom od čađe	inox vrataška 210x140, s ventilacijskom rešetkom	T-priklučni komad 60° s okapnicom
					
FU10113	FU116050	FU14	FU55	FU5150	FU1031

SPOJNI PRIKLJUČAK DIMOVODA						
dimovodna cijev 250 mm s ispuštom kond. za okom. & horiz. ugradnju	dimovodna cijev 250 mm s ispuštom kondenzata za horiz. ugradnju	klizni element 320-480 mm	mjerni element 200 mm do 200°C	zidni držač razmaka, fiksni, 50 mm	zidni držač razmaka podesiv, 50-360 mm	potpora 800-1200 mm
						
FU10110	FU10111	FU10114	FU10112	VL09	VL293	VL11

SPOJNI PRIKLJUČAK DIMOVODA		KOLJENA				
stropni ovjes za perforiranu traku	stropni ovjes za navojnu šipku M8 s umetkom za prigušivanje buke	koljeno 87° fiksno	koljeno 90° fiksno	koljeno 87° s revizijskim otvorom, fiksno	koljeno 90° s revizijskim otvorom, fiksno	koljeno okretno 0-90°
						
VL12	VL16	FU1022	FU1029	FU1023	FU1024	FU10101

Sistem EW-FU 1,0 mm dodatni dijelovi



KOLJENA		PRIBOR				
koljeno s revizijskim otvorom, okretno 0-90°	koljeno okretno 0-45°	1/2" spojnica sa zapornim vijkom	montažna spojnica 1/2" s graničnikom	univerzalni priključak utični, konusni	priključak kotla/ utični spoj	nadoplata za 1/2" spojnicu
						
FU10102	FU10101	FU125	FITT27018	FU10120	FU1032	FU126

PRIBOR						
priključak kotla/ utični spoj, konusno	međupotporanj sa kompenzatorom rastezanja	univerzalni brtveni set za priključak kotla	regulator uzgona /inox 210 x 140 mm	priključak za regulator uzgona okrugli, izlaz Ø 150 mm	regulator uzgona/inox za montažu na FU36 Ø 150 mm	regulator uzgona /inox sa štucnom i zateznom trakom Ø 154 mm
						
FU10123	FU1033	AL45V	FU35	FU1036	FU38	VL08E

PRIBOR						
poklopac otvora perforiran, inox 200 x 200 mm	rešetka za ventilaciju Ø 130, okrugla	međudržač	navojna šipka M8	cijev za odvod kondenzata Ø 20 x 1,5 mm 1000 mm	doplata za 1/2" spojnicu	sifon lijevo / desno / ravno
						
ALBI21	FU85	FU312	VL314	FU48	FU128	FU46

PRIBOR					
slavina za odvod kondenzata sa 1/2" vanjski navoj	poklopac bez zatezne brtve, matiran	poklopac uzid-nice	poklopac nastavnici sa ručkom i obujmicom	obujmica za priključenje na kotao	mineralna vuna, vreća 6 kg
					
FU47	FU50	FU43	FU44	FU1518	MINERAL-6

Sistem EW-FU 1,0 mm dodatni dijelovi

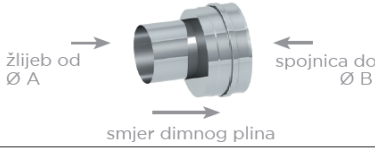
PRIBOR		PRIJELAZ
prsten za učvršćivanje 2-dijelni za navojnu šipku M10	navojna šipka M10	ekscentrično proširenje
		
ZUWA1379	VL316	EWE-EX